

Sky Climber Model: DVT-GR-8

Application: Ground Rigged, Top Rotating Davit Arm

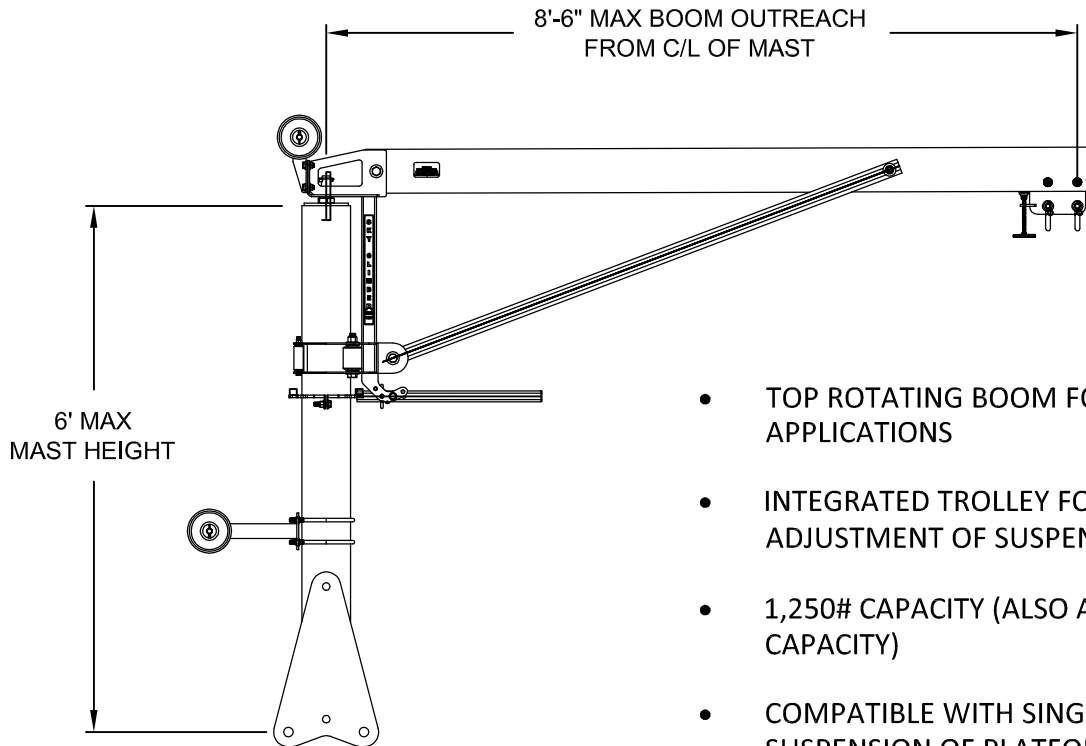

- TOP ROTATING BOOM FOR GROUND-LAUNCHED APPLICATIONS
- INTEGRATED TROLLEY FOR QUICK AND EASY ADJUSTMENT OF SUSPENSION POINT / OUTREACH
- 1,250# CAPACITY (ALSO AVAILABLE IN 1,000# CAPACITY)
- COMPATIBLE WITH SINGLE LINE AND TWO LINE SUSPENSION OF PLATFORMS (2ND SUSPENSION POINT AVAILABLE)
- MAST HEIGHT CAN BE ORDERED IN CUSTOM HEIGHTS UP TO 12'
- CUSTOM ADAPTING AVAILABLE FOR MANY PEDESTAL/SOCKET CONFIGURATIONS ALREADY IN PLACE ON EXISTING BUILDINGS
- DAVIT LIFTING WINCH AND BRACKET AVAILABLE WHERE REQUIRED

NOTE:

DAVIT IS CAPABLE OF SUPPORTING 5,000 LB. ULTIMATE LOAD AND 1,250 LB. ALLOWABLE LOAD. DAVIT MAY FAIL DUE TO IMPROPER INSTALLATION OR INADEQUATE SUPPORTING STRUCTURE. SERIOUS INJURY OR DEATH MAY RESULT FROM DAVIT FAILURE. INSTALLATION OF DAVIT MUST BE PERFORMED UNDER THE SUPERVISION OF A PROFESSIONAL ENGINEER WITH EXPERIENCE IN SUSPENDED ACCESS EQUIPMENT. ADDITIONALLY, DAVIT SHALL BE TESTED UNDER THE SUPERVISION OF A P.E. AND CERTIFIED BEFORE PLACING INTO SERVICE.

SPECIFIC CONSTRUCTION DETAILS AND APPLICATIONS VARY. THE STRUCTURE THE DAVIT BASE IS ATTACHED TO MUST BE ADEQUATE TO SUPPORT THE REQUIRED LOADING. THEREFORE, ALL INSTALLATION DETAILS MUST BE CONFIRMED BY THE BUILDING'S ENGINEER OF RECORD PRIOR TO THE INSTALLATION.