

# Sky Climber Model: ARS-CIP-10-18

Application: Roof Anchor Cast In Place

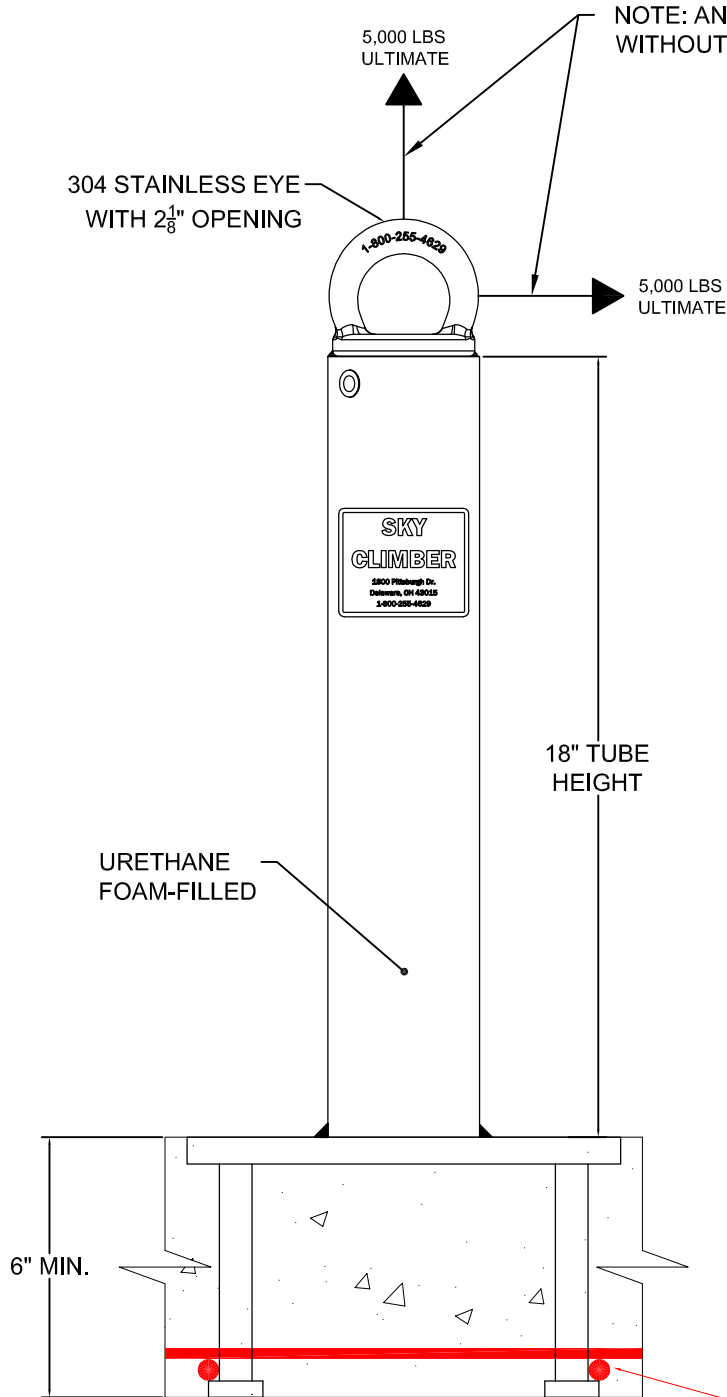

NOTE: ANCHOR WILL SUSTAIN A 5,000 LB LOAD WITHOUT FRACTURE IN EITHER TENSION OR SHEAR

- A SHORTER TUBE HEIGHT CAN BE PROVIDED IF NEEDED
- EYE IS ALSO AVAILABLE IN HIGH-STRENGTH STEEL (GALVANIZED). USE PREFIX "ARG"
- 3,000 PSI (OR GREATER) CONCRETE REQUIRED
- COMPATIBLE WITH VARIOUS REINFORCEMENT DESIGNS (BY OTHERS)

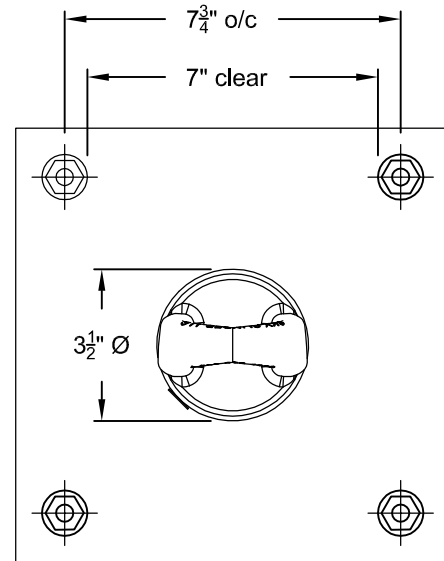

10" x 10" X 0.625" BASE PLATE

REINFORCING BAR DESIGN AND ATTACHMENT BY OTHERS

**NOTE: CUSTOMER IS RESPONSIBLE FOR THE FOLLOWING:**

- ENSURING THAT SKY CLIMBER'S ANCHORAGE PRODUCTS ARE ATTACHED TO AN ADEQUATE AND COMPATIBLE STRUCTURE.
- WHEN INSTALLED PROPERLY, SKY CLIMBER'S STANDARD ANCHOR PRODUCTS ARE DESIGNED TO SUPPORT THE FOLLOWING LOADS:
  - 1,250 LB. WORKING LOAD LIMIT (ALLOWABLE LOAD)
  - 2,500 LB. PROOF LOAD (TEST LOAD WITHOUT PERMANENT DEFORMATION)
  - 5,000 LB. ULTIMATE LOAD (LOAD AT WHICH POSSIBLE DEFORMATION MAY OCCUR TO ANCHORAGE WITHOUT FRACTURE OR FAILURE)
 HIGHER CAPACITY PRODUCTS ARE AVAILABLE BY REQUEST IF NEEDED.
- THE UNDERSTANDING THAT ANCHORS MAY FAIL DUE TO IMPROPER INSTALLATION OR INADEQUATE SUPPORTING STRUCTURE, SERIOUS INJURY OR DEATH MAY RESULT FROM ANCHOR FAILURE. INSTALLATION OF ANCHORS MUST BE PERFORMED UNDER THE SUPERVISION OF A PROFESSIONAL ENGINEER WITH EXPERIENCE IN SUSPENDED ACCESS EQUIPMENT. ADDITIONALLY, ANCHORS SHALL BE TESTED AND CERTIFIED UNDER THE SUPERVISION OF A PROFESSIONAL ENGINEER BEFORE BEING INITIALLY PLACED INTO SERVICE.
- PROVIDING INFORMATION TO THE OWNER, OR THEIR REPRESENTATIVE, VERIFYING THE ANCHOR LAYOUT COMPLIES WITH APPLICABLE LOCAL AND NATIONAL CODES, REGULATIONS, AND SAFETY STANDARDS FOR THE INTENDED USE.
- ENSURING THAT THE APPLICATION IN WHICH THE ANCHOR(S) ARE USED AND THE STRUCTURE TO WHICH IT IS ATTACHED WILL SUPPORT THE APPLICABLE LOADS INDICATED ON THIS DRAWING, THE STRUCTURE AND FIELD CONNECTION DETAILS MUST BE FULLY DEVELOPED TO RESIST THE LOADS INDICATED ON THE DRAWINGS INCLUDING MOMENT, SHEAR, AND AXIAL FORCES. THE PROJECT ENGINEER OF RECORD IS RESPONSIBLE FOR THE DESIGN ELEMENTS OF THE CONNECTION OF THE ANCHOR TO THE STRUCTURE, THESE ELEMENTS INCLUDE, BUT ARE NOT LIMITED TO: THE INTEGRITY OF THE STRUCTURE, FIELD CONNECTION DETAILS (INCLUDING ANY FIELD WELDS OR BOLTS), ADHESIVE OR MECHANICAL ANCHOR FASTENERS, REINFORCING BARS, OR ANY OTHER ELEMENT REQUIRED IN THE CONNECTION TO SUPPORT THE ABOVE LOADS.